

VANDRESTADE

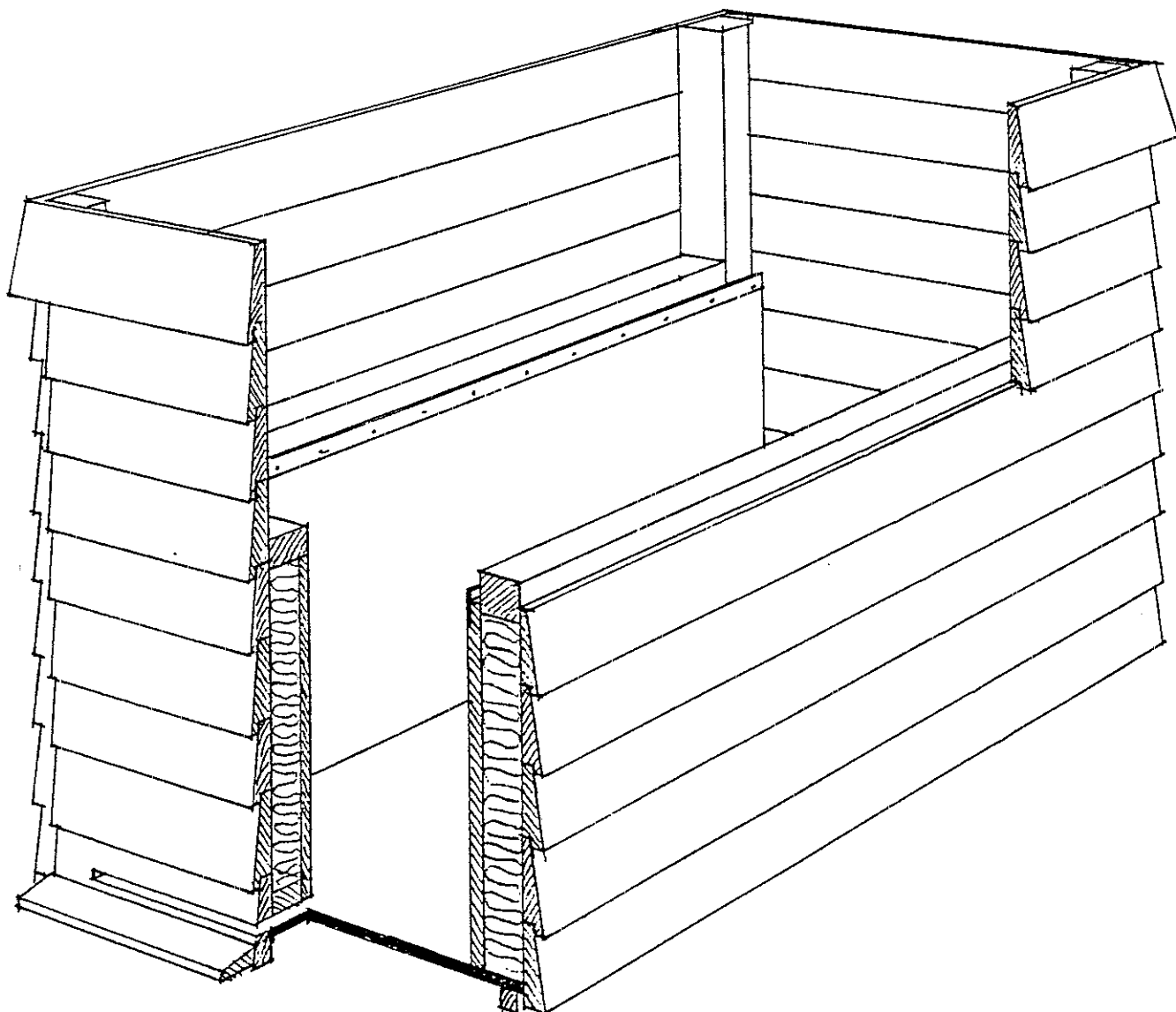

12x10

flyvebrædt 16x35

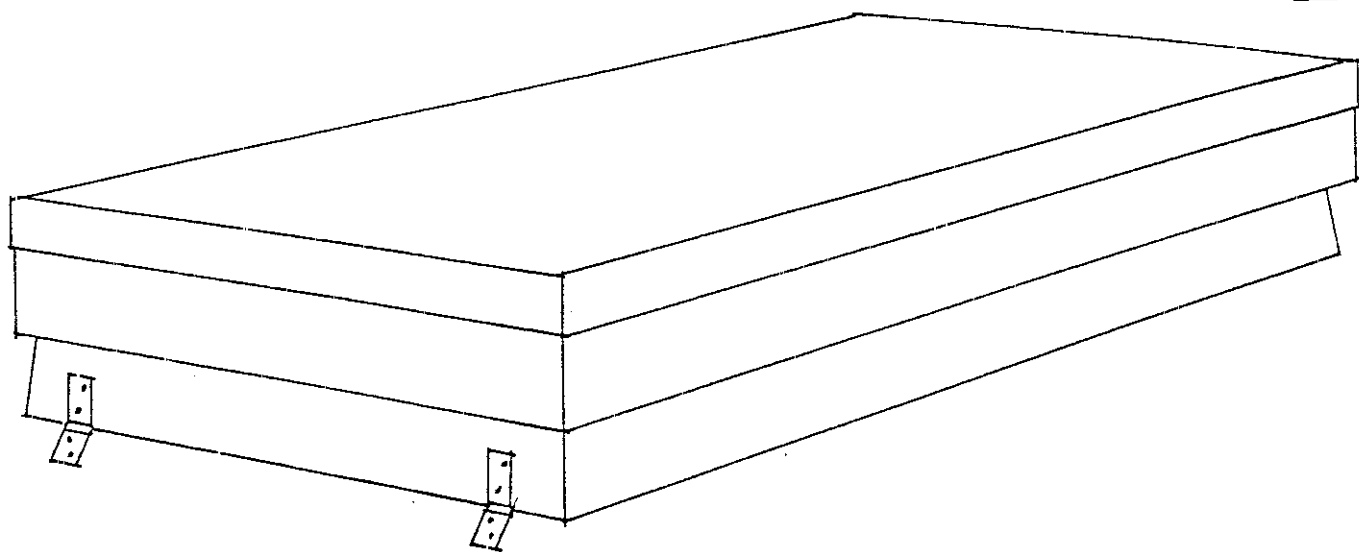
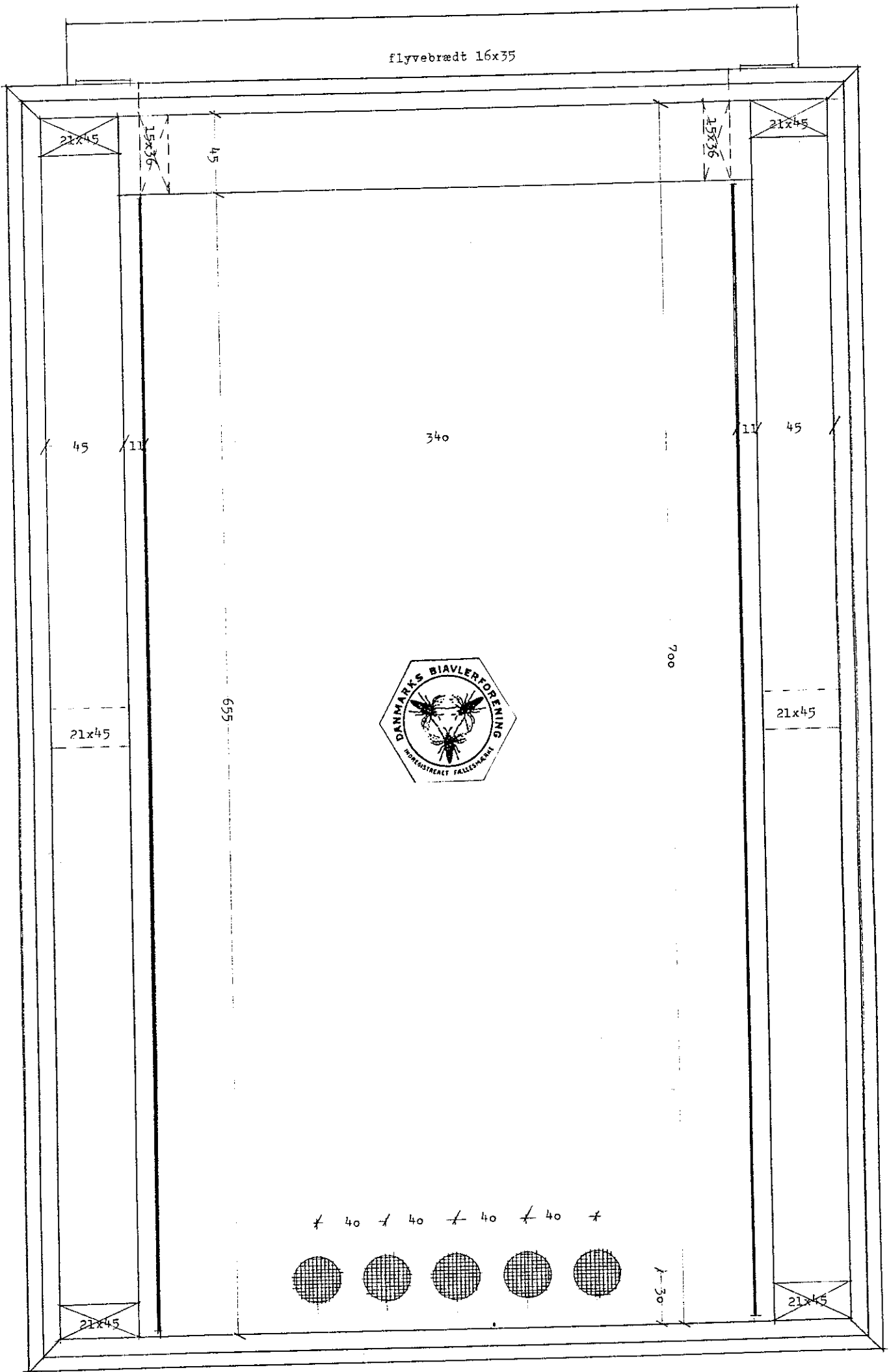

21x45

15x36

45

15x36

21x45

45

11

340

11

45

700

21x45

655



21x45

40 40 40 40 40

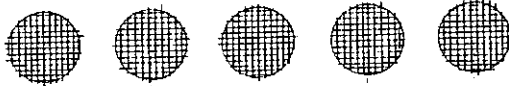

1-30

21x45

21x45

pap på 6 mm vandfast krydsfiner

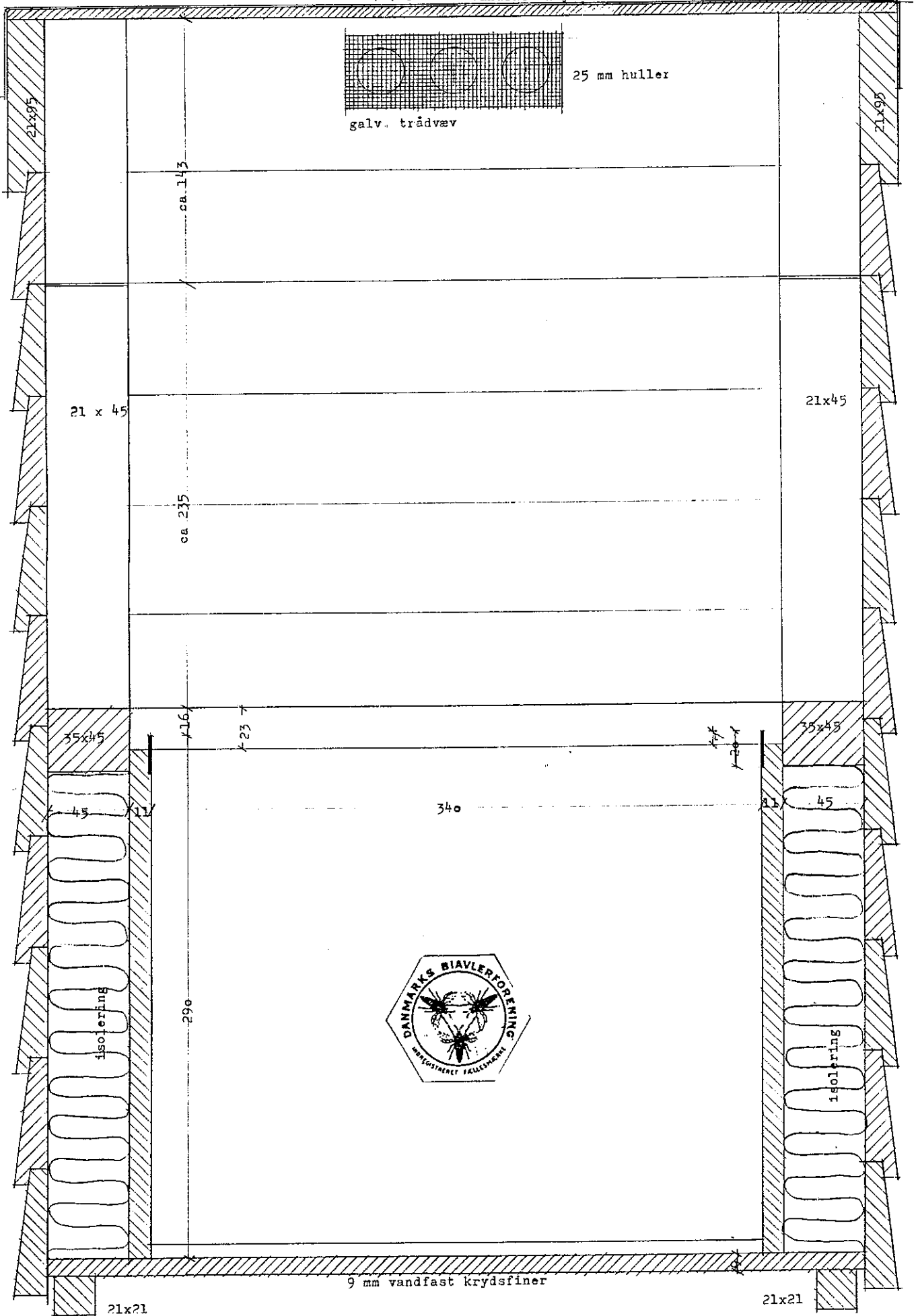



pap på 6 mm vandfast krydsfiner

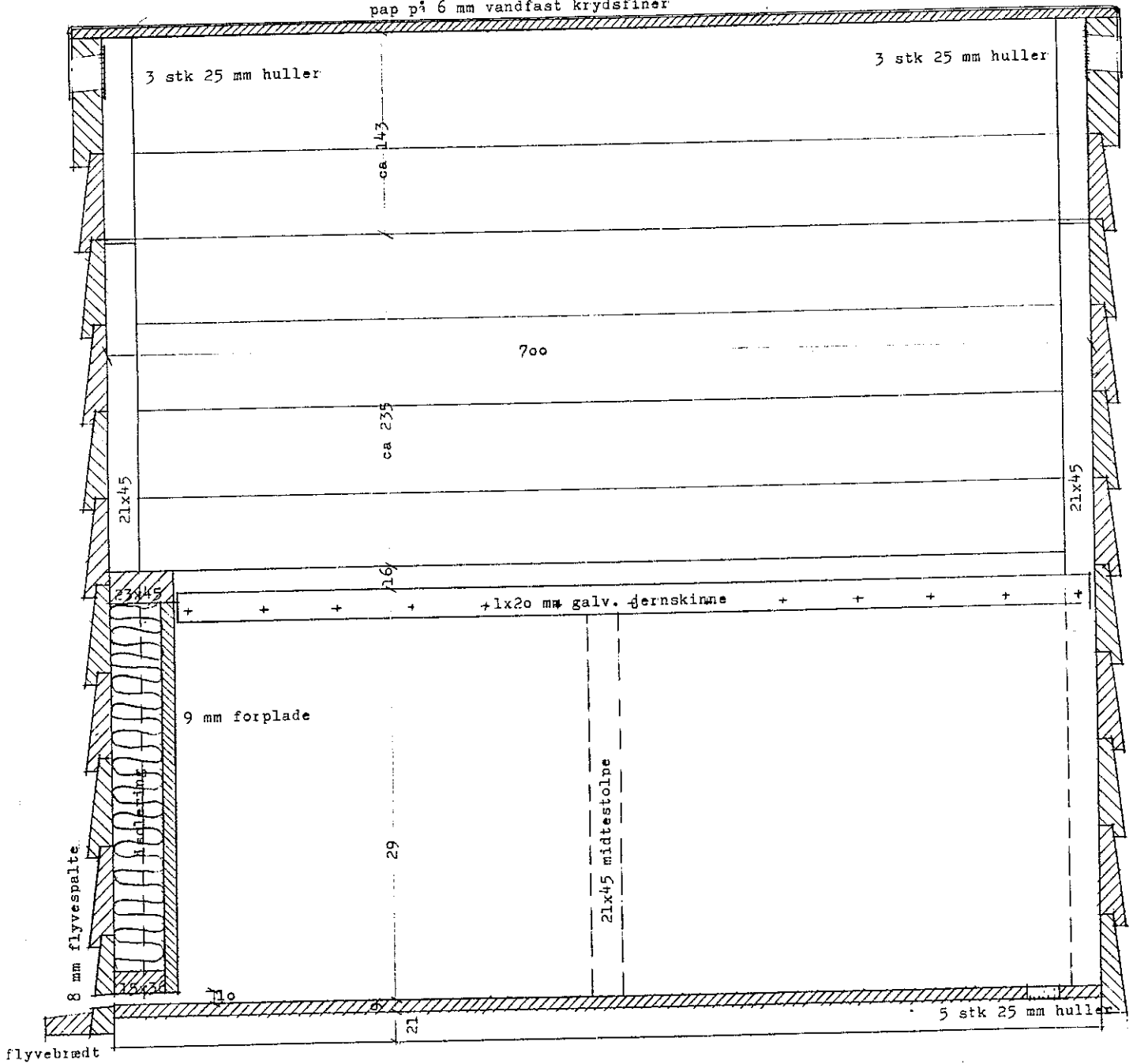

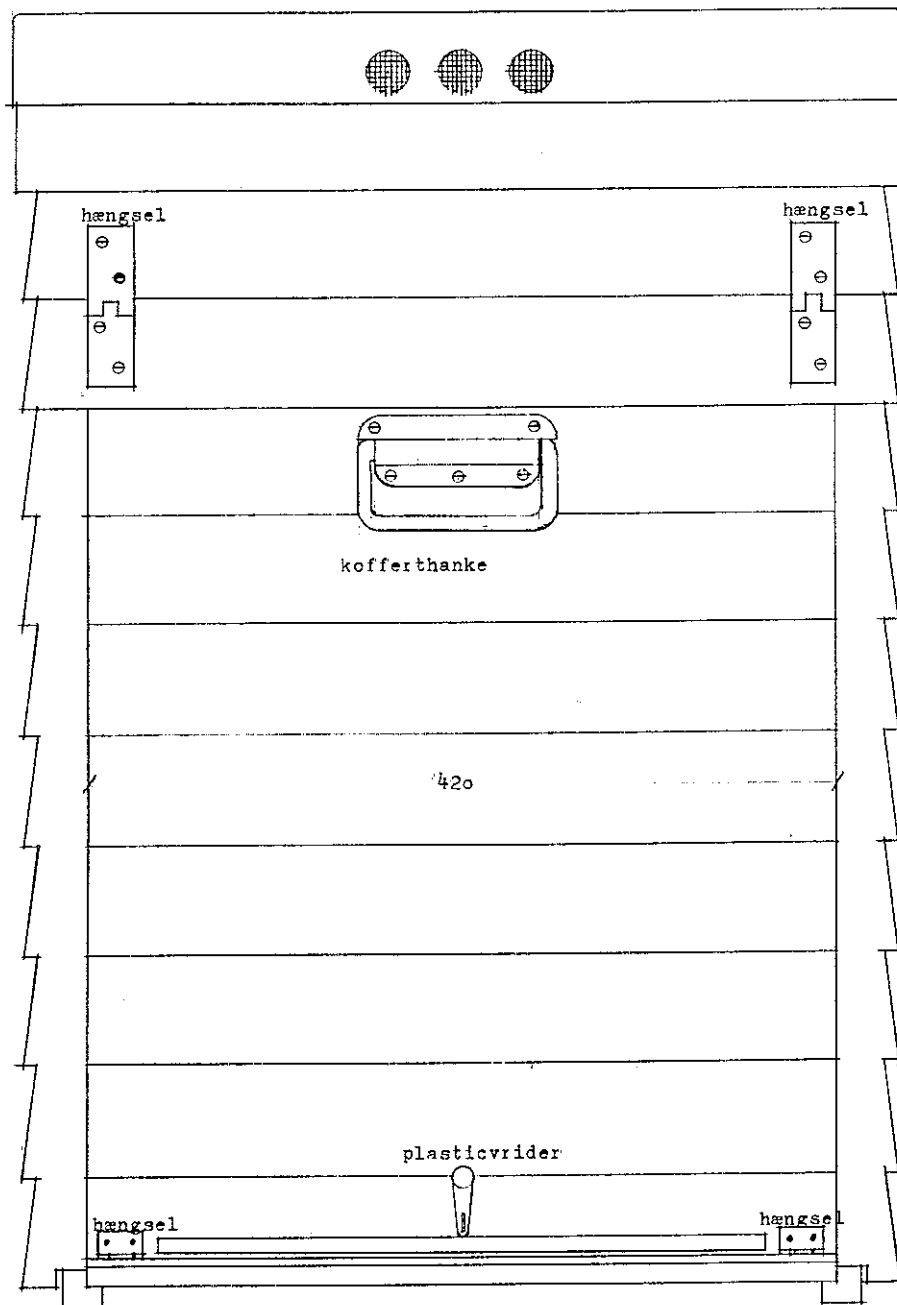

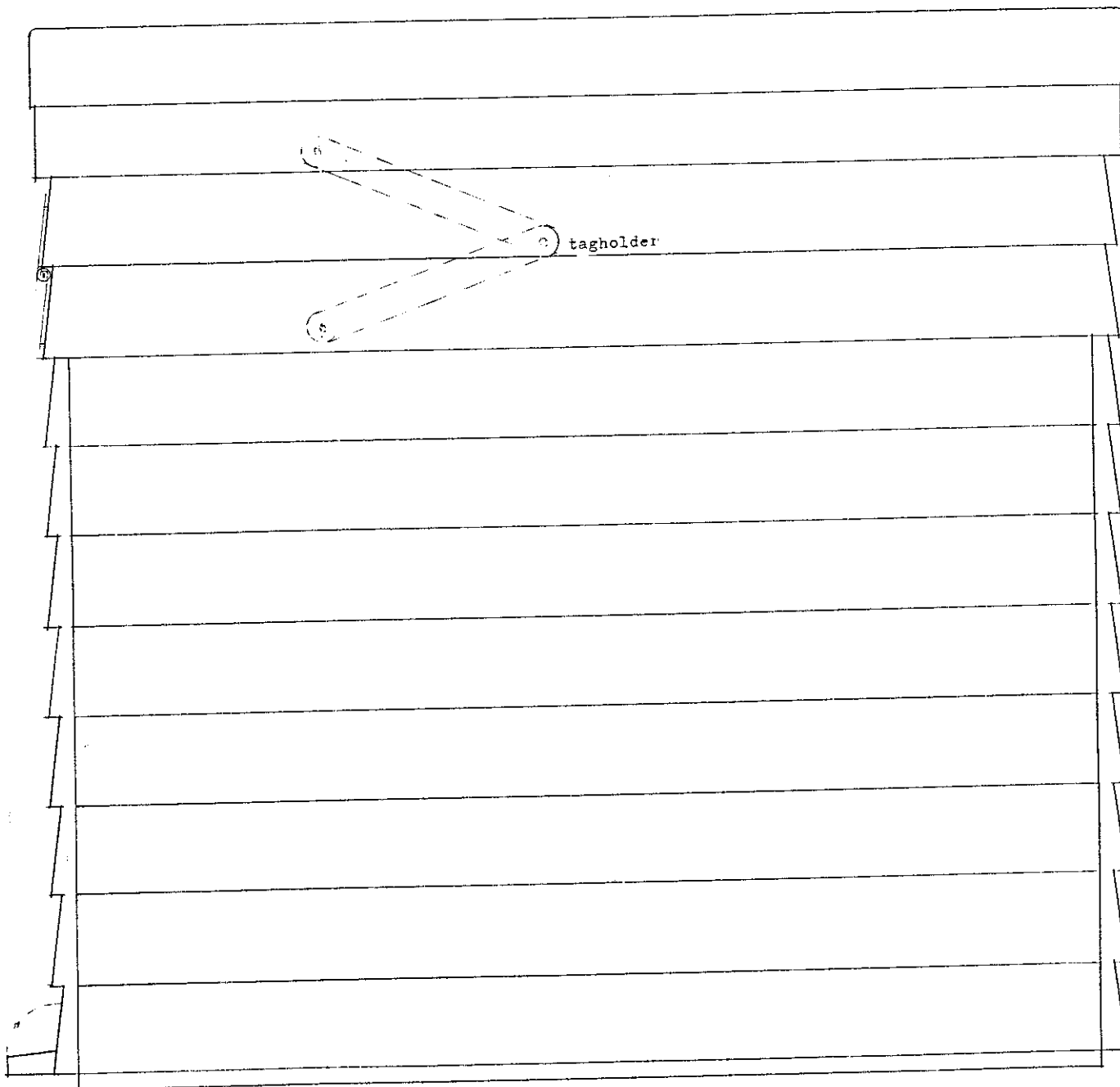

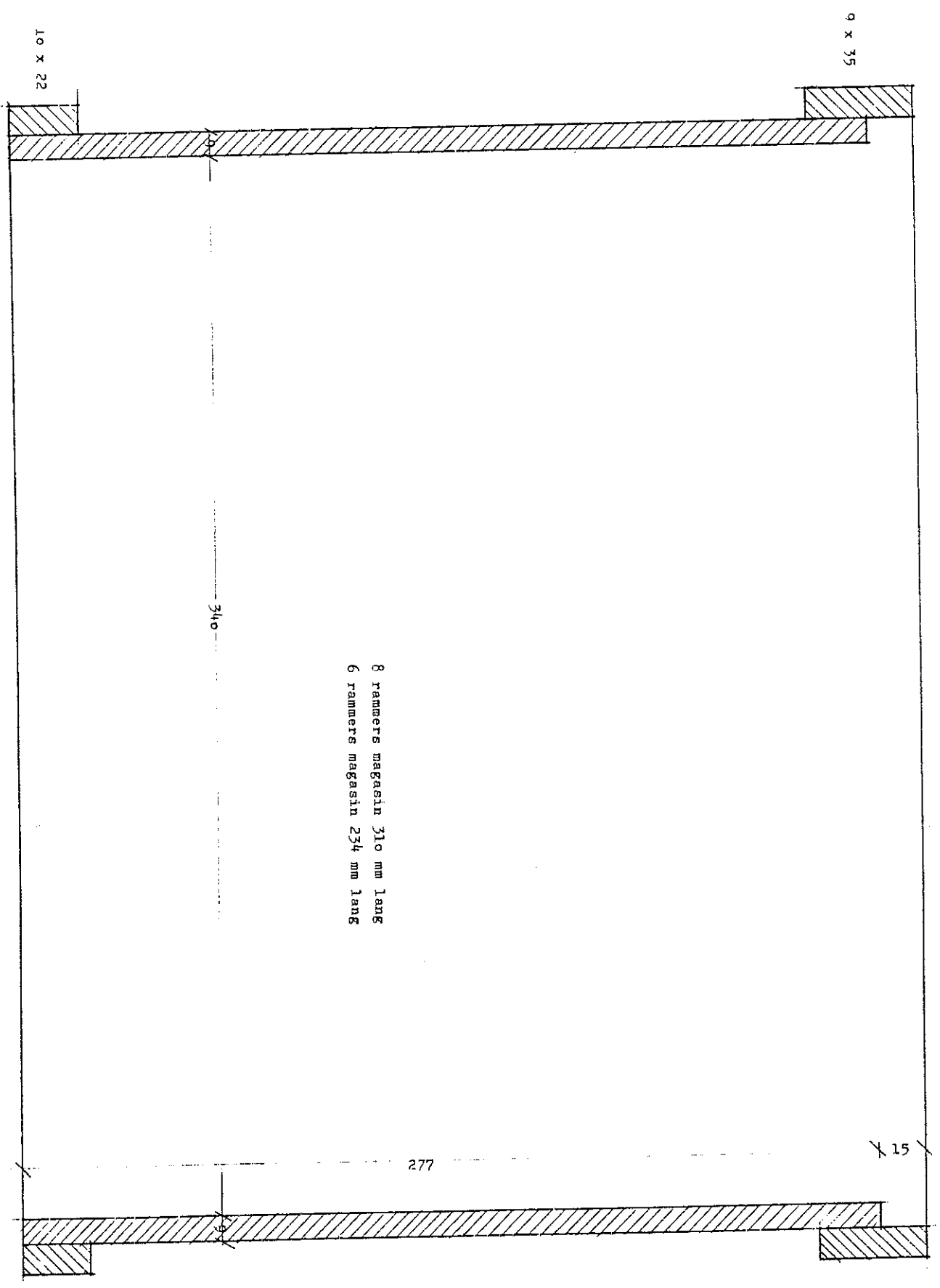

opstalt af 12x10 ramme mål 1 v

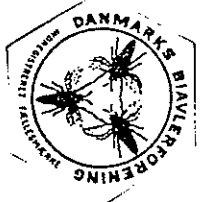
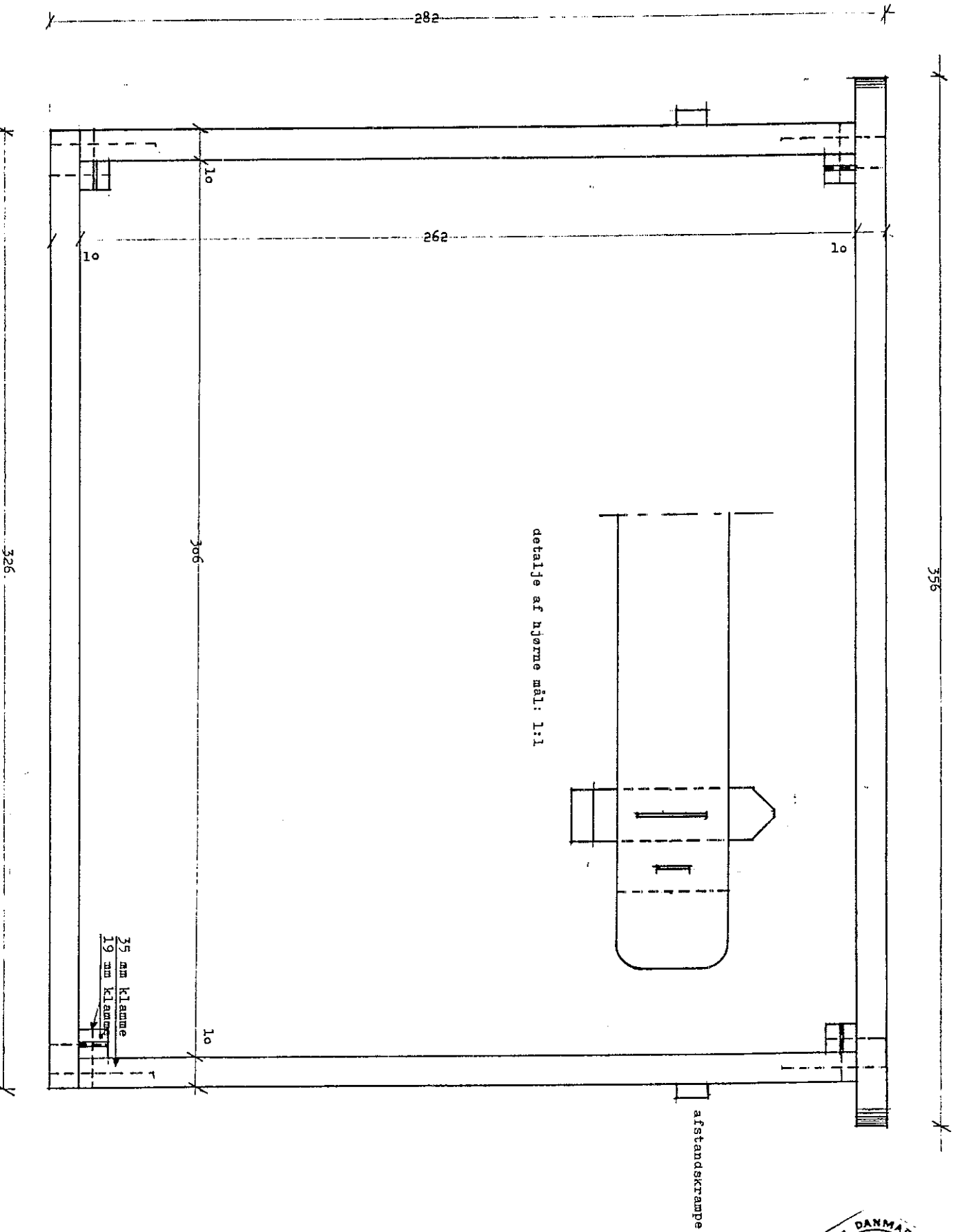



VANDRESTADE 12 x10
STYKLISTE

HJØRNESTOLPER.

4 stk. 21 x 45 x 700 mm

INDV. BEKLÆDNING.

2 stk. 12 x 290 x 700 mm. vandfast frydsfiner
1 stk. 12 x 290 x 340 mm. " "
1 stk. 9 x 452 x 700 mm. " "
2 stk. lister 35 x 45 x 700 mm.
2 stk. " 21 x 45 x 600 mm.

UDV. BEKLÆDNING.

20 stk. 19 x 75 x 700 mm.
20 stk. 19 x 75 x 450 mm.
2 stk. 21 x 21 x 700 mm.
1 stk. 19 x 60 x 450 mm.

TAG.

1 stk. 21 x 95 x 2700 mm.
1 stk. 500 x 750 mm x 6 mm. vandfast krydsfiner.
2 stk. galv. jernskinne 1 x 20 x 700 mm.
50 mm. isolering 0.5 m²
4 stk. Galv. hængsler.
2 stk. vridere
1 stk. tagholder
2 stk. kuffertgreb

De nøjagtige mål ved arbejdets udførelse tages efter tegningen.

Vandrestade 12 x 10
Stykliste

Hjørnestolper.

4 stk. 21 x 45 x 700 mm

Indv. beklædning.

2 stk 12 x 290 x 700 mm vandfast krydsfiner

1 stk. 12 x 290 x 340 mm "

1 stk. 9 x 452 x 700 mm "

2 stk. 35 x 45 x 700 mm lister

2 stk. 21 x 45 x 60 mm "

Udv. beklædning.

20 stk. 19 x 75 x 700 mm

20 stk. 19 x 75 x 450 mm

2 stk. 21 x 21 x 700 mm

1 stk. 19 x 60 x 450 mm

Tag.

1 stk. 21 x 95 x 2700 mm

1 stk. 500 x 750 mm x 6mm vandfast krydsfiner

2 stk. galv. jernskinne 1 x 20 x 700 mm

50 mm isolering 0,5m²

4 stk galv. hængsler

2 stk. vridere

1 stk. tagholder

2 stk. kuffertgreb

De nøjagtige mål ved arbejdet udførelse tages efter
tegningen.